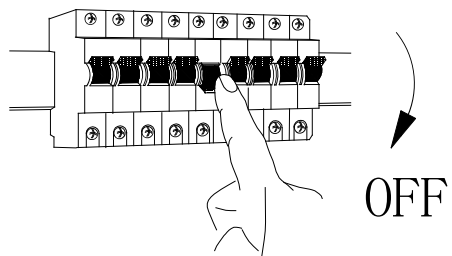
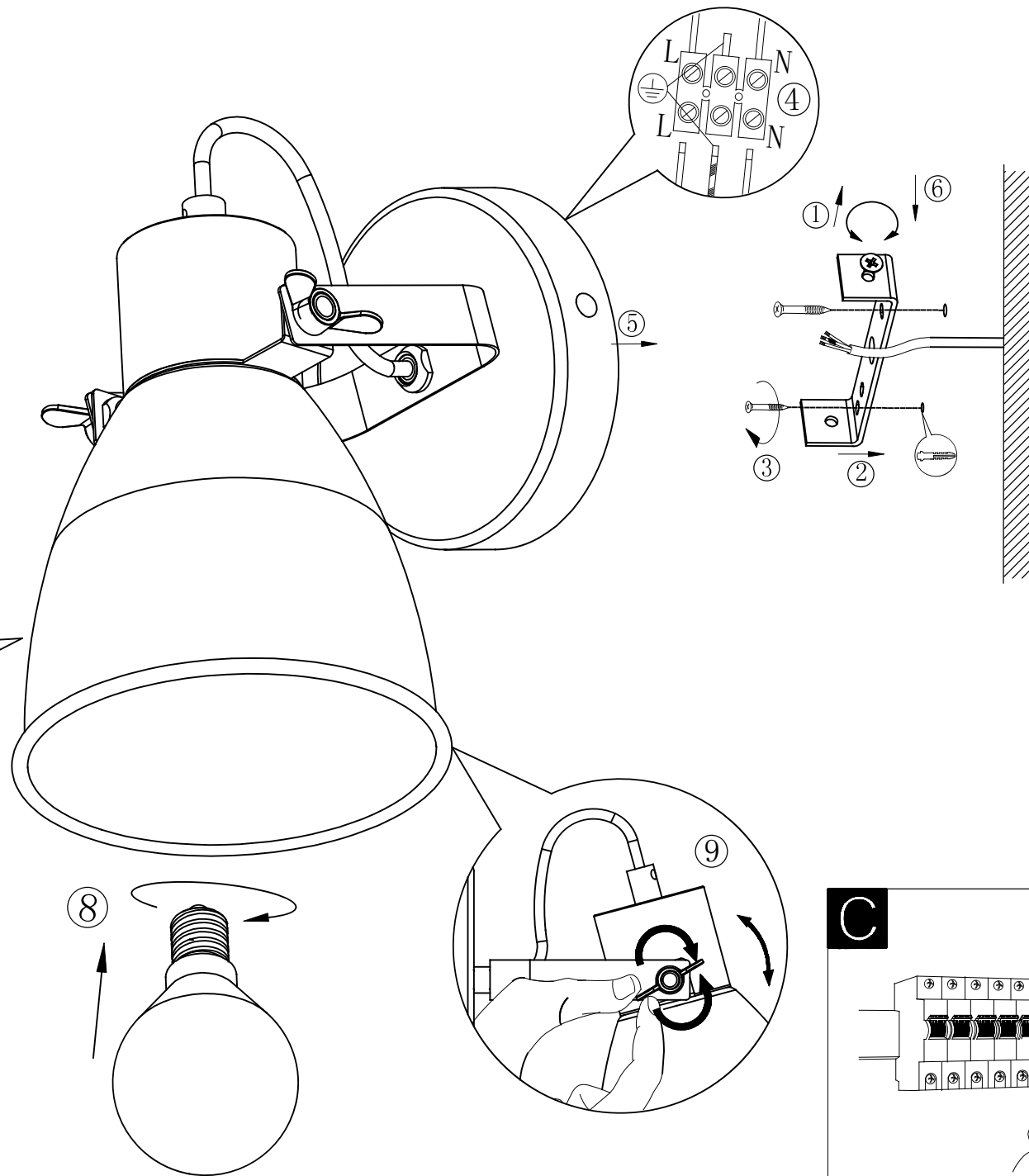
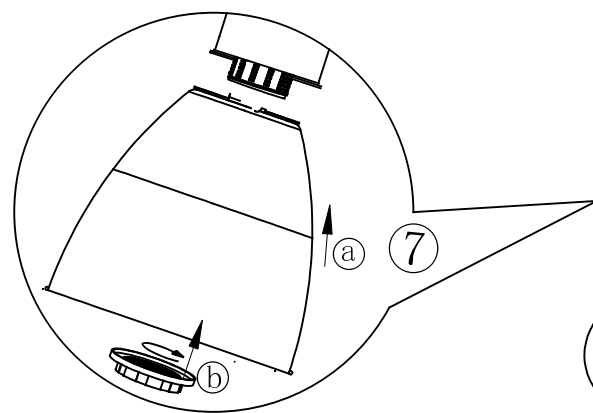
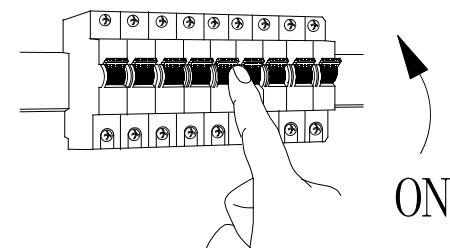

**A****B****C**

B99074  
www.eglo.com